

Mirror Cabinet Installation Instruction

1 Technical parameters

Code:
 Rated voltage: 220V ~ 240VAC Output voltage: DC12V
 Product model: □50HZ Rated power: □16W □22W

2 Installation accessories

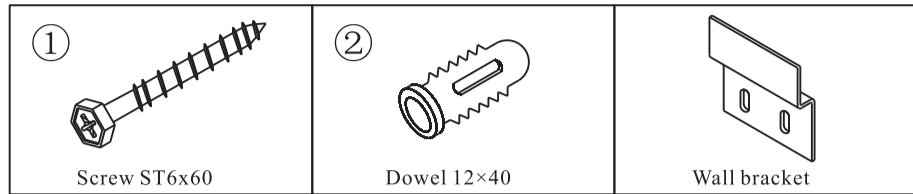

3 Installation tools

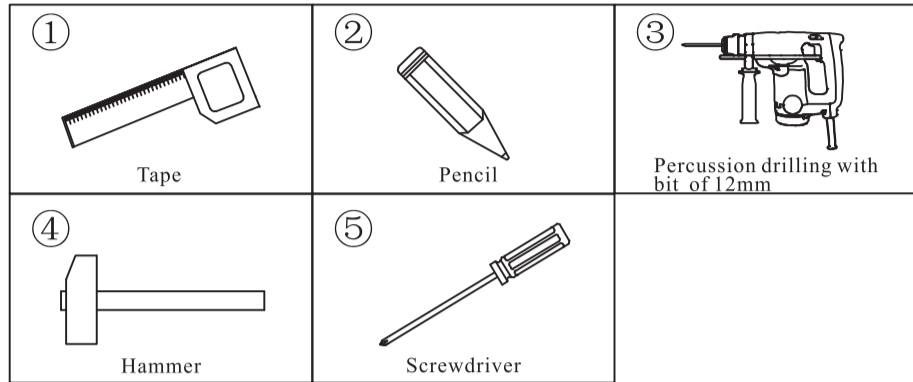

4 How to install

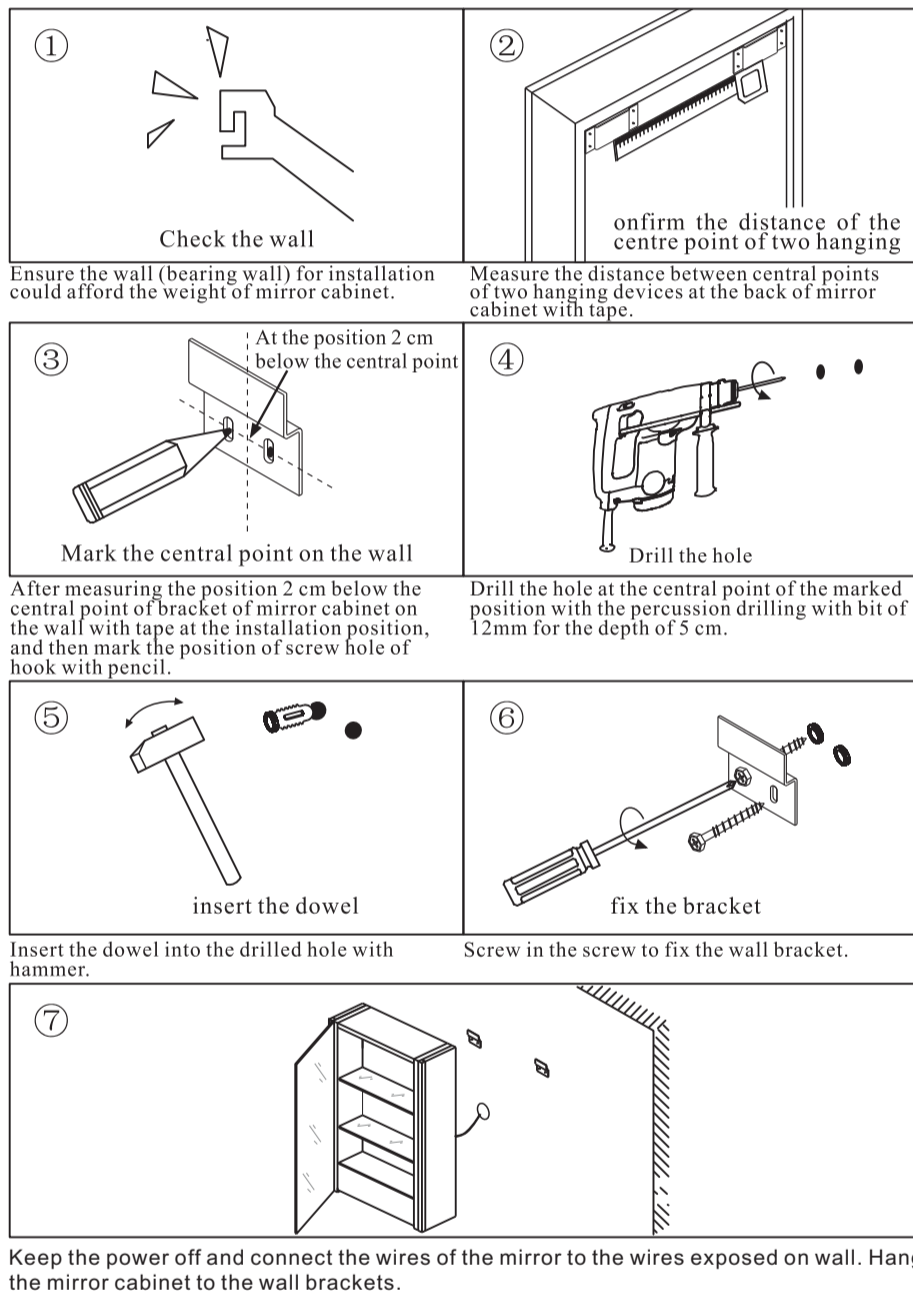

5 Wiring diagram

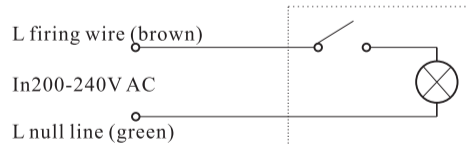

6 Operation and use instruction

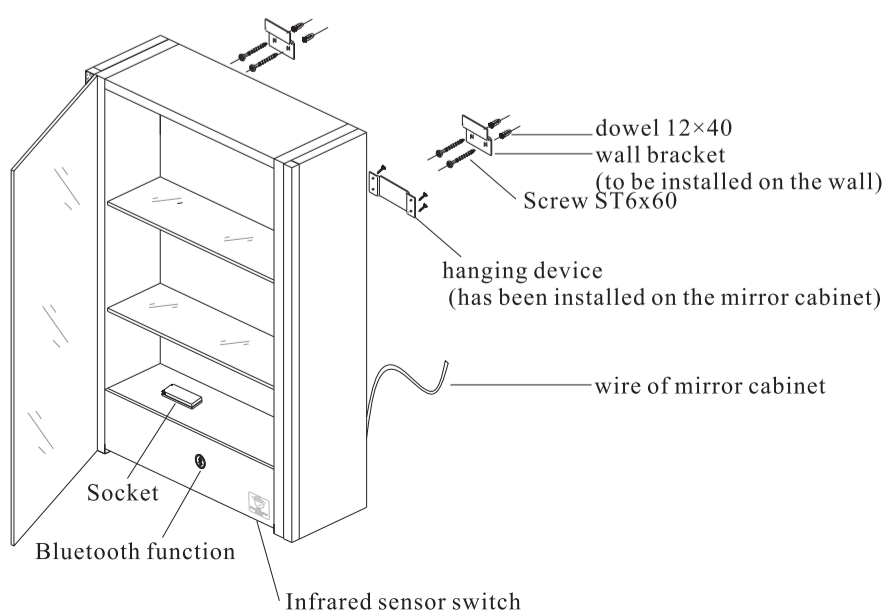

Please operate based on the product configuration function. It may ignore the functions not available on the product:

(1) LED infrared sensor switch function:

- Upon power off, the sensor switch enters the working state.
- Turn on/off the lamp:
Within the scope of valid distance of infrared sensor switch for 6cm, LED light can be turned on or off by gently waving.

Notes): Reflective materials cannot be placed within the scope of 50 cm in front of the sensor area of infrared sensor switch, such as stainless steel, mirror and faucet.

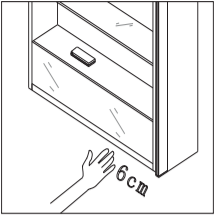

(2) LED and other touch switch function:

- Turn on the lamp:
Touch sensor switch, and the indicator light is out, and LED light is lit.
- Turn off the lamp:
Touch sensor switch, and the indicator light is lit, and LED light is out.

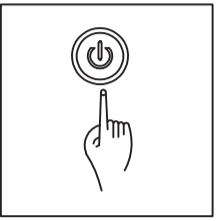

(3) Socket function

- If it should use the socket, open the waterproof cover of socket upward, and then insert the plug of electric appliance into the socket for use.
- When the socket is not used, please pull out the socket of electric appliance to avoid aging or damage of power supply of electric appliance and socket.

Notes): The socket is applied to shaver, electric toothbrush, and other electric appliances with power less than 10W/0.04A.

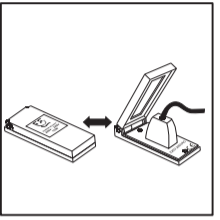

(4) Bluetooth function:

- Turn on the Bluetooth:
Touch the sensor switch on the mirror, the light off. Please wait 8-12 seconds after hearing "Du Du Du" from the speaker, you can connect the bluetooth when the hear the "DI DI" sound again.
- Turn on your mobile Bluetooth equipment (such as mobile, I Pod and other equipments with Bluetooth output), and then search equipment "YH-BT02" for matching connection. When the loudspeaker box of Bluetooth releases prompt tone, it is displayed on the mobile screen that it has been connected. After connection, it may play music any time (when the music is played, it may control the machine for pause/play, previous song, next song and volume by mobile).
Turn off the Bluetooth:

- Touch mirror Bluetooth switch key, and the indicator light is lit to indicated the Bluetooth has been turned off.

Notes):

- Please do not approach to the high-magnetic field and electric field.
- After the mobile has been connected to the Bluetooth of mirror cabinet, other mobiles will not be able to search the equipment. The other mobile only could search and connect to it after the connected mobile is turned off the Bluetooth.
- The Bluetooth applied to the machine can be compatible to most of Bluetooth equipments that have Bluetooth play function. When it cannot be matched or connected for play, please confirm the Bluetooth equipment that you use must have Bluetooth play function under normal working conditions.
- The machine is applied to Bluetooth audio input and output, and is not available for video file.

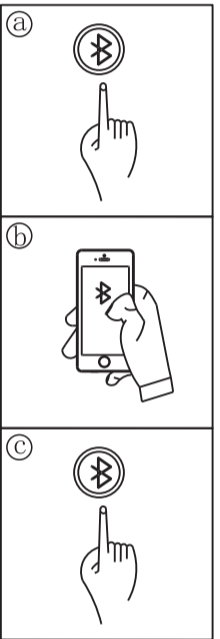

7 Precautions

(1). Installation precautions:

- WARNING: In order to prevent falling down this product must be used with the wall attachment device provided.**
- Do not make the mirror directly contact the floor when in installation. Stack up soft material to avoid crash.
 - During the installation, pay attention to prevent screwdriver and other metal objects scratching mirror surface.
 - Confirm the position for installing the mirror. Because it should drill the hole on the wall during the installation, please identify the water pipe diagram and wiring diagram of electric wire to avoid any unnecessary loss caused during the installation.
 - During the wiring, please ensure it is operated under power-off position. Do not pull the electric wire or wiring box toughly to avoid any internal wiring damage. The licensed electrician should take charge of connecting power line of product and municipal electric grid.
 - Upon installation, hold the mirror steadily with both hands and then gently shake both sides, to confirm whether the product is installed firmly.
 - After the product is powered on, the key indicator of touch switch is lit. When LED lamp, anti-fog and Bluetooth function is active, the switch indicator is out.

(2). Precautions for daily use:

- Please turn off general power when in cleaning mirror cabinet. Wipe with clean cloth that wetted with a small amount of fresh water. Do not wipe the product surface with corrosive material or unclean cloth to avoid affecting the bright mirror. Finally, dry it with dry cotton cloth to maintain the mirror clear.
- Do not scratch the product surface with hard objects, such as wire brush and abrasion sponge and blade, and also do not strike with hard object.
- Do not wipe the paint film at the back of mirror with detergent as it contains corrosive ingredients.
- After cleaning the mirror with detergent, it must be immediately rinse with fresh water again and wipe it clean. Do not leave any detergent on the mirror surface or penetrate into the mirror. For the residual detergent will form the scale on the mirror surface to cause oxidation upon moisture evaporation.
- Pay attention to interior ventilation. The bathroom installed dedicated mirror also cannot use acid detergent, such as hydrochloric acid and sulfuric acid when in cleaning house and bathroom floor and wall, for the corrosive liquid will make the bathroom air have content of acid, and easily oxidize and damage the mirror surface, so that the mirror will have black edge or spots, and the surface of metal accessories also will be corrosive and become yellow.

8 Warning

- This appliance is for household and indoor use only. Don't use it outdoors!
- If the external flexible cable or cord of this luminaire is damaged, it shall be exclusively replaced by the manufacturer or his service agent or a similar qualified person in order to avoid a hazard.
- To keep the appliance clean, wipe away the enclosure with damp cloth and then dry it with another clean dry cloth. Never immerse the main body in water for cleaning!
- To protect against electric shock, do not immerse main parts of the product, cord or plug in water or other liquids.
- The light source contained in this luminaire shall only be replaced by the manufacturer or his service agent or a similar qualified person.
- This luminaire is provided with connecting leads (tails) requiring a separate terminal block for the connection to the fixed wiring, and the luminaire has provided adequate space for the specific terminal block. The terminal box shall be approved according to EN 60998-2-1 or EN 60998-2-2; and shall comply with below specification: the type of terminal (screw/screwless); number of terminals; (2 terminals for L/N connecting); rated voltage; (>450 V); rated connecting capacity; (0.75-2.5mm²) the wire end must clamped by crimp terminal wire connector to prevent the free wire of conductor escaping; the terminal block must be protection against of electric shock; fixing the terminal block by glue; Connect up the brown wire to 'L' terminal, and blue wire connected to 'N' terminal.
- DISPOSAL:**
Do not dispose this product as unsorted municipal waste. Collection of such waste separately for special treatment is necessary. This product must not be disposed together with the domestic waste. This product has to be disposed at an authorized place for recycling of electrical and electronic appliances. By collecting and recycling waste, you help save natural resources, and make sure the product is disposed in an environmental friendly and healthy way.

